



F220 & Net2 LCD Mimics

F220 Full Function Mimic
F220 Enhanced Mini-Mimic
F220 Alarm Mini-Mimic

Net2 Network Control Unit
Net2 Network Enhanced Mini-Mimic
Net2 Network Alarm Mini-Mimic

Overview

Pertronic F220 & Net2 LCD Mimics provide remote access to information from F220 fire alarm control panels, or from Net2 Network Systems.

There are three types of F220/Net2 LCD Mimics. Each type may be configured as either an F220 panel mimic, or a Net2 network mimic, by fitting the appropriate firmware.

When used as F220 panel mimics, these units display information from the connected panel only. When used as Net2 network mimics, they can be programmed (In FireUtils®) to display information from selected panels, or from the entire network. In addition, the Net2 Enhanced Mini-Mimic and the Net2 Alarm Mini-Mimic can be programmed to monitor specific zones.

All Pertronic F220 & Net2 LCD Mimics have the same 7 inch (180 mm) colour LCD display used on the F220 fire alarm control panel. The coloured display screens clearly identify the panel status. Red status bars and large easy to read text descriptors identify the Alarm mode.

The F220 Full Function Mimic and the Net2 Network Control Unit (NCU) provide full control and display of all functions.

The F220 and Net2 Enhanced Mini-Mimics are capable of accessing all system event information, including faults, pre-alarms, and disablements.

The F220 and Net2 Alarm Mini-Mimics display Alarms and Warning System On. They are designed for staff who are responsible for responding to alarms.

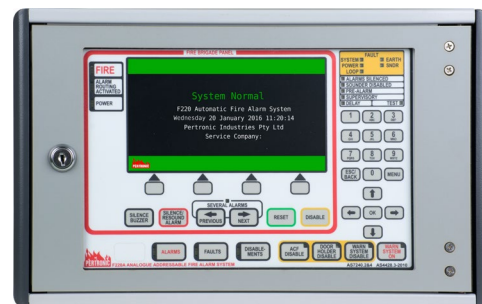

Pertronic F220 Full Function Mimic.
When fitted with Net2 network firmware, this unit becomes the Pertronic Net2 Network Control Unit

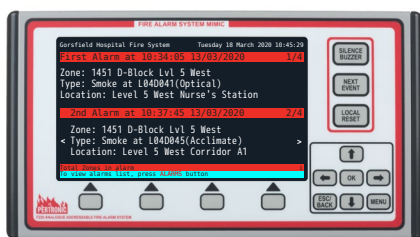

F220 Alarm View displayed on an F220 Enhanced Mini-Mimic

F220 & Net2 LCD Mimics communicate via the F220's External High-Speed RS-485 Bus, or the Net2 network card's Network Peripheral Bus. The bus provides a 24 Volt DC power supply suitable for powering mimics. Standalone DC power supplies such as Pertronic AS 7240.4 Auxiliary Power Supplies may be used to power the mimics on installations where voltage drop or current consumption exceed the bus's capability. Alternatively, bus power may be fed from the fire panel's power supply unit.

Features

- » Remote display for F220 Fire Alarm Control Panel or Net2 Network System
- » Seven-inch 800 x 480 pixel TFT LCD colour display
- » Coloured display screens clearly identify panel status
- » Easily readable 5 mm text height on Alarm screen
- » Local Alarm buzzer
- » Internal local buzzer disable switch
- » Output for a remote Alarm buzzer
- » Cable length up to two kilometres, when using a Pertronic RS-485 Repeater/Splitter

Products

F220 Full Function Mimic / Net2 Network Control Unit

Performs all the keyboard and display functions of the F220 fire alarm control panel from a remote location.

When configured as a Net2 Network Control Unit, this unit may be programmed (using FireUtils®) to control selected F220 panels in a Net2 network. It may also be programmed to display information from additional connected F220 panels. Alternatively, it may be configured to control an entire Net2 Network.

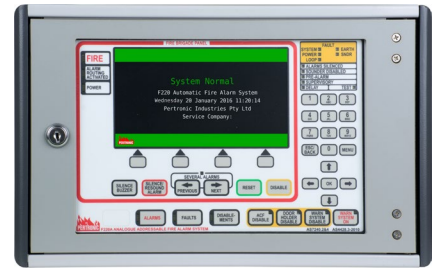

Features

- » Keyboard-Display identical to F220 fire alarm control panel keyboard-display including:
 - Full F220 menu controls with Door Holder and ACF Disable with individual LED indication
 - Cursor control keypad for event and menu navigation
 - Numeric keypad for menu navigation and data entry
 - Four context-sensitive Soft Function Keys
- » External control inputs: Warning System On (“TE”), Silence Alarms (“BCO”)
- » Auxiliary Fault Input on F220 Full Function Mimic only
- » Output for External Buzzer

F220 Enhanced Mini-Mimic / Net2 Network Enhanced Mini-Mimic

Provides access to all available information from the F220 fire alarm control panel, including all event screens and event logs.

When configured as a Net2 Network Enhanced Mini-Mimic, this unit may be programmed (using FireUtils®) to display information from selected zones, selected F220 panels, or the entire network.

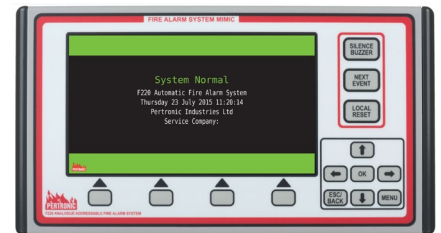

Features

- » LOCAL RESET button (if enabled) allows non brigade calling, latched detector alarms to be reset. This button may be disabled via DIP switch.
- » NEXT EVENT button selects the next item on the display list. For example: From the Alarm View it selects the next device in alarm; from the Alarm List it selects the next alarm in the list
- » Cursor control keypad for event and menu navigation
- » Four contact-sensitive Soft Function Keys operate similar to the soft function keys on the F220 control panel
- » Output for External Buzzer

F220 Alarm Mini-Mimic / Net2 Network Alarm Mini-Mimic

Displays only Alarm screens and Warning System screen. Designed for use by staff who are responsible for responding to alarms.

When configured as a Net2 Network Enhanced Mini-Mimic, this unit may be programmed (using FireUtils®) to display information from selected zones, selected F220 panels, or the entire network.

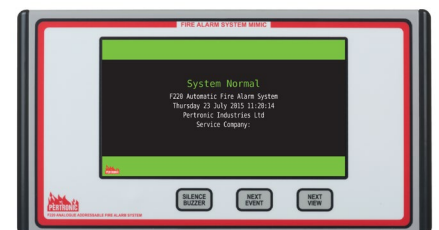

Features

- » NEXT VIEW button: Switches between different Event Type screens
- » NEXT EVENT button selects either: The next device in alarm, from the Alarm View; or the next alarm in the list, from the Alarm List.
- » SILENCE BUZZER button
- » Output for External Buzzer

External High-Speed RS-485 Bus

The F220 External High-Speed RS-485 Bus supports a range of peripherals including LCD Mimics. The bus runs over a 4-wire cable. A twisted pair of wires carries the balanced data circuit. The other two wires carry the 24 V power circuit.

The Net2 Network Card also has an external RS-485 bus for use with the Net2 Network Control Unit and Net2 mini-mimics. This bus is generally similar to the F220 External RS-485 Bus. The comments below apply to both the F220 and Net2 external high-speed RS-485 buses.

Data Circuit

Mimics and other peripherals are connected across the data circuit in a multi-drop (“daisy-chain”) configuration.

For satisfactory performance, each bus segment must be a point to point transmission line with no branches or spurs.

The Pertronic RS-485 Repeater/Splitter may be used to create up to five separate RS-485 bus segments. Each segment, including the segment from control panel to splitter, may be up to one kilometre from end to end. The F220 External High-Speed RS-485 Bus must not have more than two segments connected in cascade.

Every bus segment must be terminated at each end with a terminating resistor equal to the data circuit’s characteristic impedance. For typical fire-rated twisted pair cables a 100 ohms resistor provides a suitable end of line termination.

The F220 and the Net2 Network Card have terminating resistors permanently connected to their external RS-485 ports. Terminating resistors are supplied with every mimic, to be fitted if required. Please consult the relevant installation instructions about terminating resistors for other peripherals.

Note: DO NOT fit terminating resistors to mimics or peripherals at intermediate locations on a bus segment.

Power Circuit

The RS-485 bus provides a nominal 24 Volts DC power supply for mimics and other peripheral devices.

However, voltage drop on long cable runs can be significant. Pertronic Industries strongly recommends that voltage drop calculations should be used to check that adequate voltage will be available to mimics and peripherals. For F220 mimics the total volt drop must not exceed 4 Volts. This ensures the mimics will work properly on battery power, even if the battery voltage falls to 19 Volts.

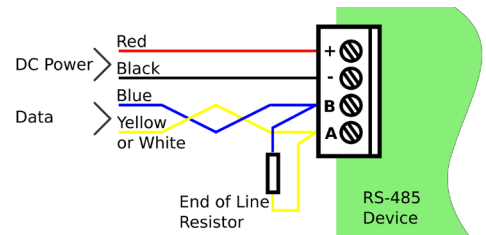

Typical External High-Speed RS-485 Bus Connections at an F220 mimic, with terminating resistor

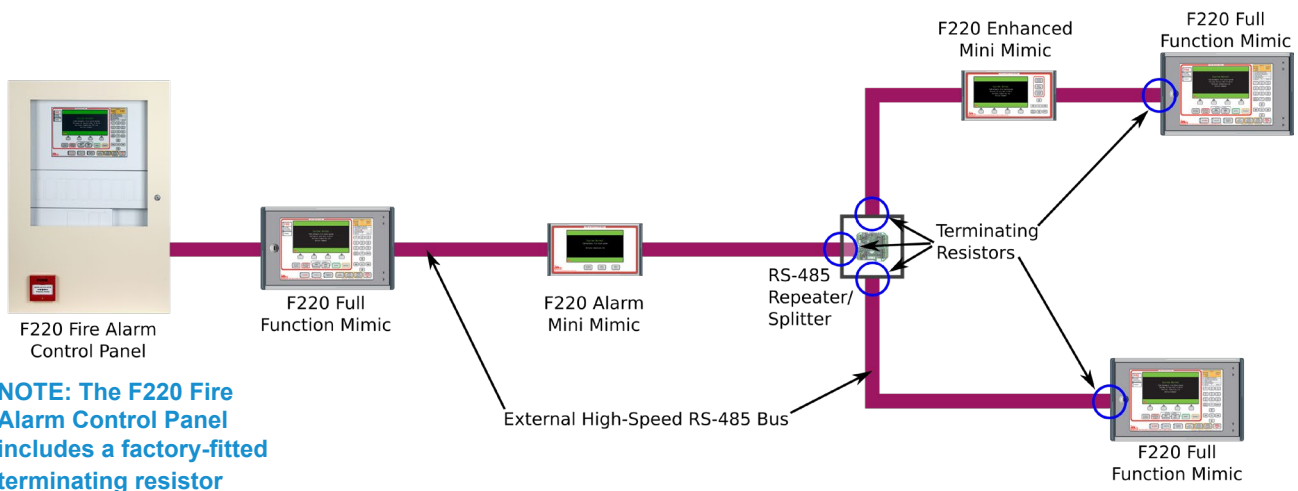

Concept diagram of an F220 system with mimics. Blue circles identify terminating resistor locations.

Specifications

F220 & Net2 Mimics

	Full Function Mimic	Enhanced Mini-Mimic	Alarm Mini-Mimic
F220 Panel Mimic	F220-FFMA	F220-EMMA	F220-AMMA
Net2 Network Mimic	Net2-NCUA	Net2-EMMA	Net2-AMMA
Supply Voltage	15 – 30 Vdc	15 – 30 Vdc	15 – 30 Vdc
Standby Current @ 27 Vdc			
Backlight @ 0%	42 mA	42 mA	42 mA
Backlight @ 50%	60 mA	60 mA	60 mA
Backlight @ Maximum	82 mA	82 mA	70 mA
Alarm Current @ 27 Vdc			
Backlight @ 50%	80 mA	63 mA	60 mA
Backlight @ Maximum	100 mA	82 mA	72 mA
Max. Backlight Brightness	100 %	100 %	80 %
External Buzzer Output	12 Vdc, max 50 mA		
Dimensions (W x H x D mm)	375 x 235 x 52	267 x 146 x 31	267 x 146 x 31
	Plus lock protruding 5 mm forward from front face		
Weight	3 kg	1.35 kg	1.35 kg
Cabinet Material	Mild Steel	Mild Steel, with Moulded End Stops	
Cable Requirement	2-Core (Twisted Pair) Data + 2-Core Power		
Cable Termination	0.5 to 2.5 mm ² , Stranded Cable, Plug-in Terminal Blocks		
Chassis Colour	Apo Grey (Dulux 915 32786, Croda 6506, Ameron PE549/6506)		
End Stop Colour	Grey Friars (Dulux 915 58711, Croda 6499, Ameron AP746/6637)		
Operating Temperature	-10 °C to +50 °C		
Humidity	≤ 95 % RH, non-condensing		

F220 External High-Speed RS-485 Bus & Net2 Network Peripheral Bus

Data Rate	115.2 kbit/s	
DC Current Capacity:		
External High-Speed RS-485 Bus	1.4 A	If more current is needed, DC power may be fed from the fire panel's power supply unit
Net2 Network Peripheral Bus	0.25 A	
Maximum Segment Length	1 km	
Maximum Overall Length	2 km	With Pertronic RS-485 Repeater/Splitter
Maximum Cascaded Segments	2	Using no more than one RS-485 Repeater/Splitter
End of line (EOL) Termination	100 Ω, 0.5 W	Each end of each segment (refer to page 3)
Mimics per F220 Panel	Maximum 32 mimics in total, including up to 8 F220 Full Function Mimics	
NCU / Mimics per Network Card	Maximum 8 Net2 Network Control Units and/or Net2 Mini-Mimics (Note that every Net2 Network System must have at least one Net2 Network Control Unit)	

Ordering Information

Product Code	Description	Product Code	Description
F220-FFMA	F220 Full Function Mimic	Net2-NCUA	Net2 Network Control Unit
F220-AMMA	F220 Alarm Mini-Mimic	Net2-AMMA	Net2 Alarm Mini-Mimic
F220-EMMA	F220 Enhanced Mini-Mimic	Net2-EMMA	Net2 Enhanced Mini-Mimic
RS485REP	RS485 5 Way Repeater/ Splitter		

The information in this document must not be treated as partial or complete instructions for the design, construction, installation, commissioning, or maintenance of fire detection, fire alarm, or building evacuation systems. Fire and evacuation systems must be designed and installed by properly qualified persons, in accordance with all regulatory requirements.

Unless explicitly stated otherwise, this document provides typical specifications and nominal dimensions. Actual product performance and dimensions may vary.

All information in this document is subject to change. Please consult Pertronic Industries or visit our web site for up to date information.

PERTRONIC® and FIREUTILS® are registered trademarks of Pertronic Industries Limited.