

1. Terminate field wiring in the Push Fit Terminal Connector as shown taking care to maintain continuity of any shielding provided.

Positive (+) communication loop: Terminals 3 & 4  
Negative (-) communication loop: Terminals 1 & 2

2. Set the call point address according to the designated project drawings by using a flat bladed screwdriver to turn the two rotary switches, selecting the desired number between 01 and 159. Note: The number of addresses available will be dependant on panel capability, check the panel documentation for confirmation. Address 00 set at the factory is recognised as a fault condition by the control panel.

3. Plug the Terminal connector onto the rear of the call point as shown.

4. Fix Cover to mounting box taking care that all cables are secure and have sufficient clearance

#### **WIRING**

Connection to the WCP is made via the 4 way terminal connector as shown overleaf

Each terminal will accommodate a conductor of 2.5mm<sup>2</sup>.

#### **EARTHING**

An Earth Continuity Terminal is situated in the rear of the back box. This is designed to accommodate 2 conductors of up to 2.5mm<sup>2</sup>.

An earthing plate is provided for continuity of metal conduits. This must be placed behind the back box prior to fixing the box to the wall.

#### **IMPORTANT NOTES**

**The use of lubricants, cleaning solvents or petroleum based products should be avoided.**

The integral back box has three 20mm diameter threaded holes. Two hole stoppers are provided for use as required. The cable entry holes of the back box must not be subjected to stress by the cable or conduit.

#### **INSTALLATION DETAILS - Please read carefully**

Do not connect circuit wiring to this call point, other field devices or the control panel, or apply power to any portion of the system until all necessary wiring polarity, continuity and insulation tests have been performed. All wiring must conform to applicable local and national regulations and codes of practice.

Note: For CPD Data on all relevant devices please request

D974.

# KAC INSTALLATION INSTRUCTIONS FOR THE WATERPROOF MANUAL CALL POINT MODELS WCP5A....,

## Model WCP5A

These models are designed for use as components of a compatible fire control system using appropriate analogue addressable devices.

## Model WCP5A-xP07sz

Advanced Protocol - non-Isolation.  
This model provides both signalling of alarm to the monitoring control panel, and local led indication of activation.

## Model WCP5A-xP08sz

Advanced Protocol - with Isolation.  
This model provides both signalling of alarm to the monitoring control panel, and local led indication of activation. This model also includes on board isolation, providing short circuit protection of the loop.

x represents the character used to indicate WCP colour.  
z represents the character used to indicate element type.

## GENERAL

These Call Points are suitable for IP67 environments.

## LED STATUS (TRI COLOUR)

The LED status is controlled by Fire Panel commands and can be set to pulse Green each time the device is polled, or continuous Red to indicate Fire. Yellow is used to indicate isolator status.

## WALL MOUNTING OF BACK BOX

Mount the back box to a suitably flat surface using the three fixing holes and the screws provided in the installation pack. The cable entry holes should be in the vertical plane. The back box can be mounted with either the single or the double entry holes at the top.

## FITTING THE WCP COVER TO THE BACK BOX

Plug the 4 way terminal connector onto the appropriate position as shown. Ensure that the O-ring is correctly seated in the channel on the rear of the cover. Place

the cover squarely over the back box and carefully push the cover until the locating clips have engaged. Do not use excessive force. It is recommended that the 4 cover fixing screws are used to lock the cover into place.

## WCP COVER REMOVAL

To remove the cover, undo and remove the 4 Cover fixing screws. Place the edge of a large flat bladed screwdriver into the slot between the Cover and back box as shown in below and gently twist until the latches are disengaged. Pull cover away from the back box.

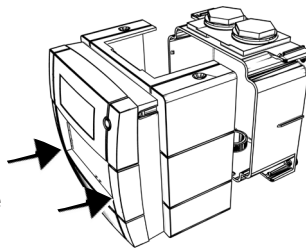
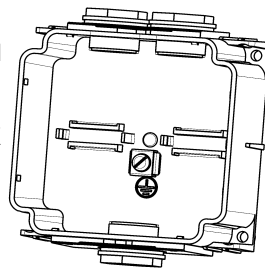
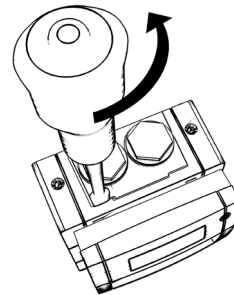
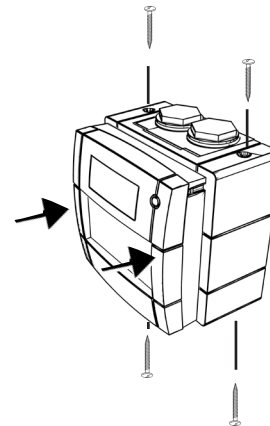

## CONNECTION DETAILS

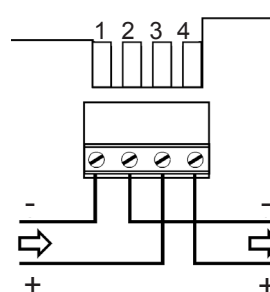

## DIMENSIONS

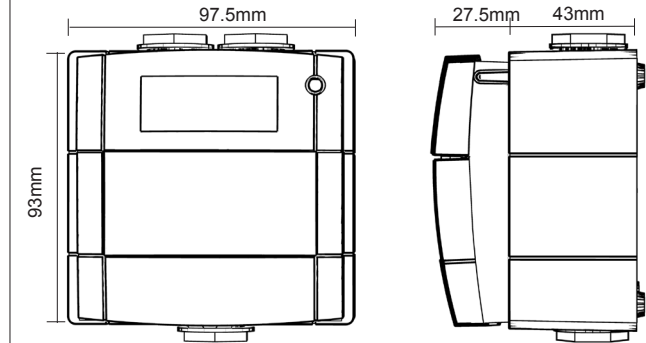

## PUSH FIT CONNECTOR

After wiring the terminal connector, plug into the appropriate position, see connection details (left).

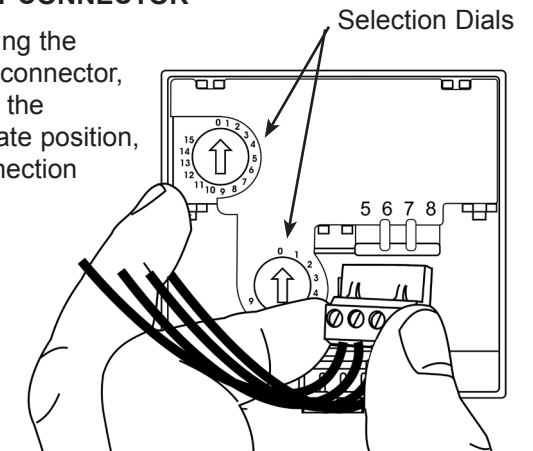

## TECHNICAL DATA

 15V Min  
30VDC Max

 Quiescent 350µA Max (24V no comms)  
660µA Typ (24V with comms)

Alarm 6mA Typical  
LED Red 2mA Typical  
LED Yellow 7.5mA Typical

Note:- A minimum input voltage of 17.5V is required for correct LED operation. Under this threshold the device will switch off the LED output to reduce current draw.

 IP67

For isolator specification refer to document S00-368-000 available on request

 1kg

350g

 °C

-25°C to +70°C



Red, Ral 3001  
Yellow, Ral 1006

Green, Ral 6024

White, Ral 9010

Blue, Ral 5005